

CU2 FIRE DAMPER

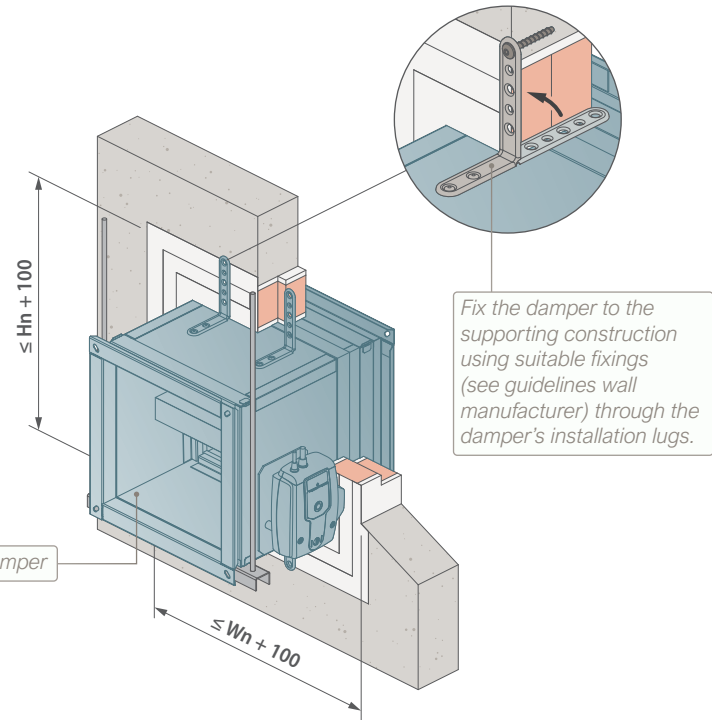

Fix the damper to the supporting construction using suitable fixings (see guidelines wall manufacturer) through the damper's installation lugs.

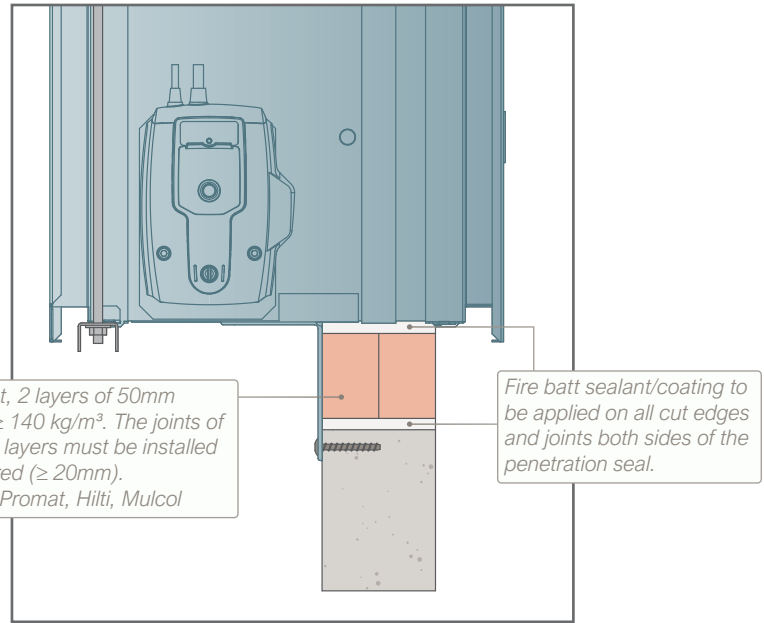

Supporting construction (slab or other)

Damper to be supported by unistrut from min. M8 drop rods, washers and nuts from horizontal supporting construction above. Let the fire damper rest upon the unistrut, do not fixate.

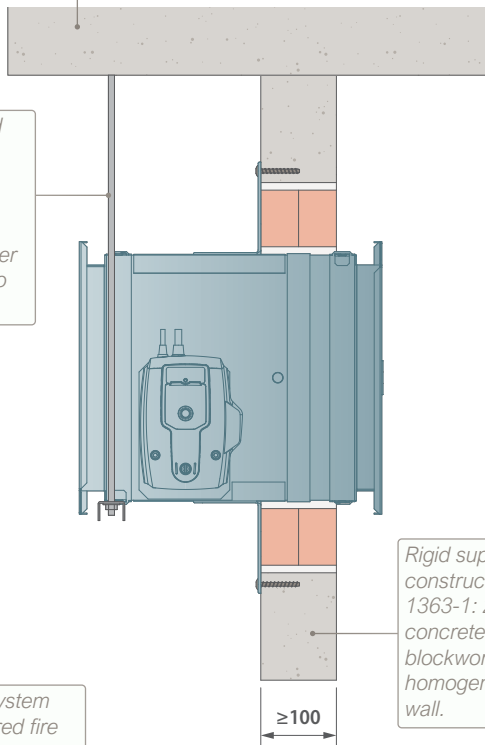

Rigid supporting construction to BS EN 1363-1: 2020. Aerated concrete block wall, blockwork, masonry or homogenous concrete wall.

- If distance from damper tunnel to horizontal supporting construction $\geq 75 \text{ mm}$: apply 2 layers of fire batt as shown above.
- If distance from damper tunnel to horizontal supporting construction ≥ 50 and $< 75 \text{ mm}$: apply fire batt (density min. 150kg/m^3) between fire damper and horizontal supporting construction over a total depth of 400 mm. Not required to coat the fire batt nor use coated fire batt.
- If distance from damper tunnel to horizontal supporting construction ≥ 25 and $< 50 \text{ mm}$: apply stone wool (density min. 40 kg/m^3) compressed by 40% between fire damper and horizontal supporting construction over a total depth of 400 mm. Not required to coat the stone wool

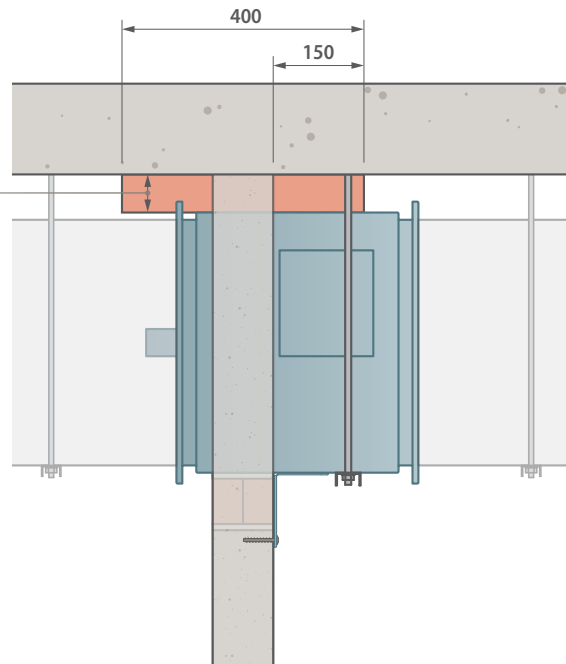

Dimension suspension system acc. to weight and required fire resistance.

TECHNICAL FEATURES

- Damper range (WxH): 200x200 till 1200x800.
- Damper can be installed with blade in vertical or horizontal position.



- Damper can be installed with mechanism on either side of the wall (independent of fire side).
- Please consult with the fire batt manufacturer for appropriate sealant/coating.
- For larger wall openings. See CU2 Fire Damper Technical Datasheet.
- A max. of 2x2 fire dampers can be installed at tested minimal distances from an adjacent horizontal or vertical (supporting) construction or another fire damper. See detailed guidelines in the CU2 Technical Datasheet.

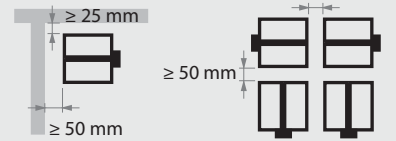

- To be read in conjunction with the CU2 Fire Damper Technical Datasheet.
- Guidelines acc. to DW144/145 (not required for CE):
 - Installation lugs as shown in the drawings are available upon request.
 - Provide appropriate break-away / flexible joint between fire damper and connecting ductwork on both sides of the assembly (DW145: eg socket & spigot or flanged with appropriate fixings eg plastic cleats, clips, clamps, bolts, aluminium alloy rivets etc.).
 - Provide a panel in the adjacent ductwork to allow access to the internal components of the fire damper. Rf-T can provide an inspection opening on the damper body upon request (option UL).
 - Ductwork must be independently supported and installed (DW144).
- Dimensions in mm unless otherwise stated.

TECHNICAL DATASHEET



INSPECTION AND HANDOVER CHECK LIST



PLAN TITLE

CU2 fire damper in rigid supporting construction. Installation detail with fire batt.

CLASSIFICATION

EI 60/90 (ve i↔o)S



REV
B

DATE
24/09/2024



CU2 FIRE DAMPER

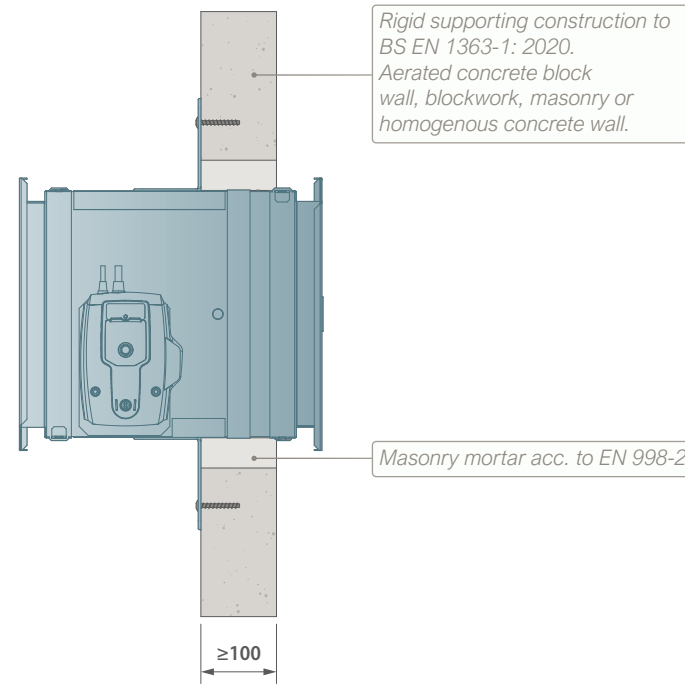
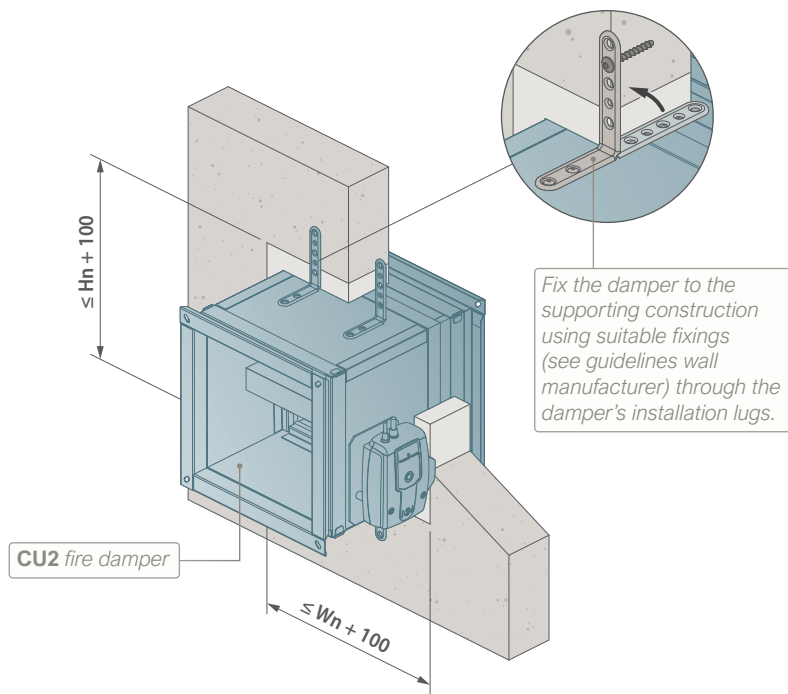

- If distance from damper tunnel to horizontal supporting construction ≥ 75 mm : apply masonry mortar as shown above.
- If distance from damper tunnel to horizontal supporting construction ≥ 50 and < 75 mm : apply fire batt (density min. 150kg/m^3) between fire damper and horizontal supporting construction over a total depth of 400 mm. Not required to coat the fire batt nor use coated fire batt.
- If distance from damper tunnel to horizontal supporting construction ≥ 25 and < 50 mm : apply stone wool (density min. 40kg/m^3) compressed by 40% between fire damper and horizontal supporting construction over a total depth of 400 mm. Not required to coat the stone wool

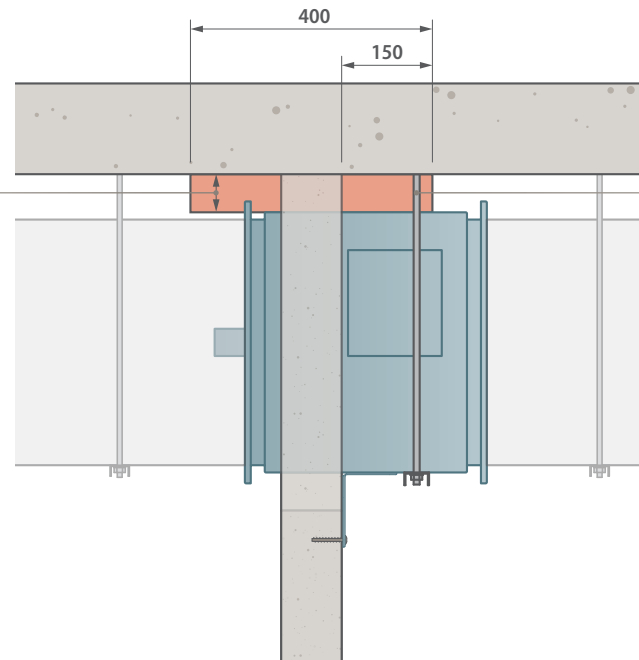

If not possible to fix the lug to the vertical supporting construction above the damper due to space constraints, support the damper by unistrut from min. M8 drop rods, washers and nuts from the horizontal supporting construction. Let the damper rest upon the unistrut, do not fixate. Dimension suspension system acc. to weight and required fire resistance.

TECHNICAL FEATURES

- Damper range (WxH): 200x200 till 1500x1000.
- Damper blade position is defined by the required classification and damper size:

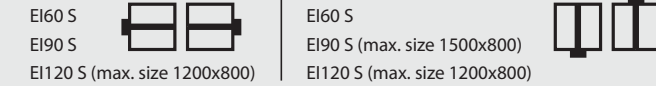

- Damper can be installed with mechanism on either side of the wall (independent of fire side).
- A max. of 2x2 fire dampers can be installed at tested minimal distances from an adjacent horizontal or vertical (supporting) construction or another fire damper. See detailed guidelines in the CU2 Technical Datasheet.

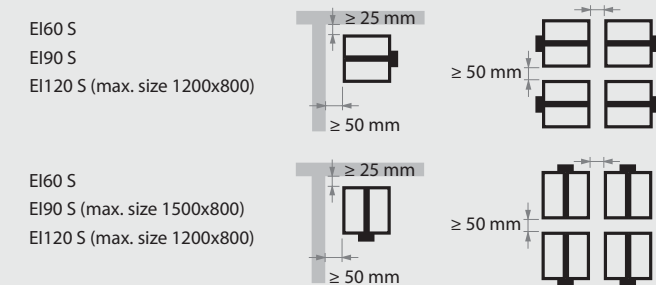

- To be read in conjunction with the CU2 Fire Damper Technical Datasheet.
- Guidelines acc. to DW144/145 (not required for CE):
 - Installation lugs as shown in the drawings are available upon request.
 - Provide appropriate break-away / flexible joint between fire damper and connecting ductwork on both sides of the assembly (DW145: eg socket & spigot or flanged with appropriate fixings eg plastic cleats, clips, clamps, bolts, aluminium alloy rivets etc.).
 - Provide a panel in the adjacent ductwork to allow access to the internal components of the fire damper. Rf-T can provide an inspection opening on the damper body upon request (option UL).
 - Ductwork must be independently supported and installed (DW144).
- Dimensions in mm unless otherwise stated.

TECHNICAL DATASHEET



INSPECTION AND HANDOVER CHECK LIST



PLAN TITLE

CU2 fire damper in rigid supporting construction. Installation detail with mortar.

CLASSIFICATION

EI 60/90/120 (ve i↔o)S



REV
B

DATE
24/09/2024



CU2 FIRE DAMPER

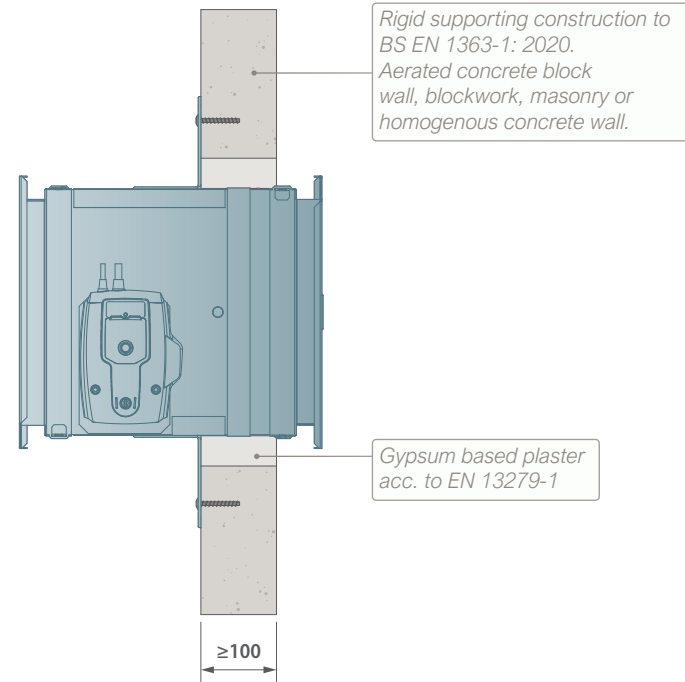
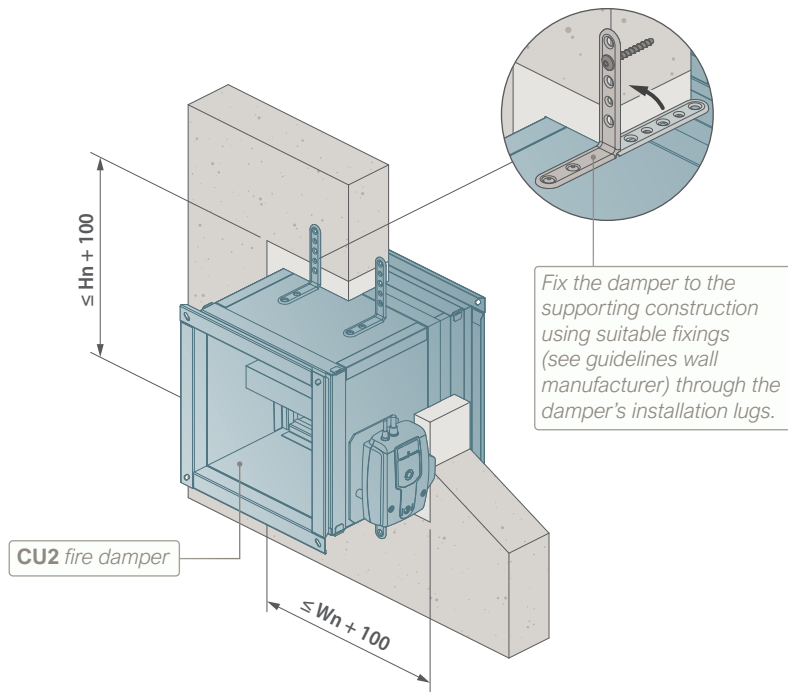

- If distance from damper tunnel to horizontal supporting construction ≥ 75 mm : apply gypsum based plaster as shown above.
- If distance from damper tunnel to horizontal supporting construction ≥ 50 and < 75 mm : apply fire batt (density min. 150kg/m^3) between fire damper and horizontal supporting construction over a total depth of 400 mm. Not required to coat the fire batt nor use coated fire batt.
- If distance from damper tunnel to horizontal supporting construction ≥ 25 and < 50 mm : apply stone wool (density min. 40kg/m^3) compressed by 40% between fire damper and horizontal supporting construction over a total depth of 400 mm. Not required to coat the stone wool

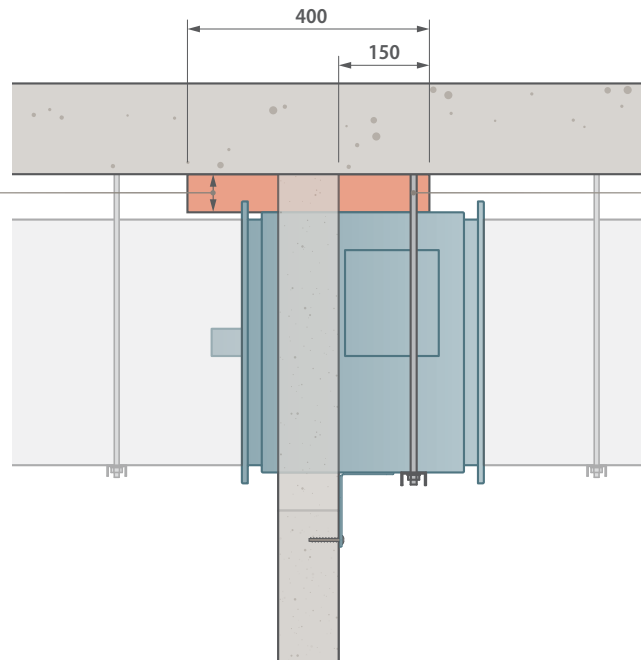

If not possible to fix the lug to the vertical supporting construction above the damper due to space constraints, support the damper by unistrut from min. M8 drop rods, washers and nuts from the horizontal supporting construction. Let the damper rest upon the unistrut, do not fixate. Dimension suspension system acc. to weight and required fire resistance.

TECHNICAL FEATURES

- Damper range (WxH): 200x200 till 1500x1000.
- Damper blade position is defined by the required classification and damper size:

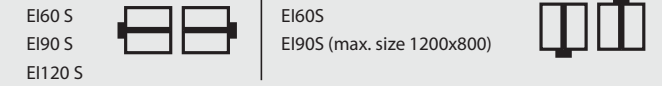

- Damper can be installed with mechanism on either side of the wall (independent of fire side).
- A max. of 2x2 fire dampers can be installed at tested minimal distances from an adjacent horizontal or vertical (supporting) construction or another fire damper. See detailed guidelines in the CU2 Technical Datasheet.

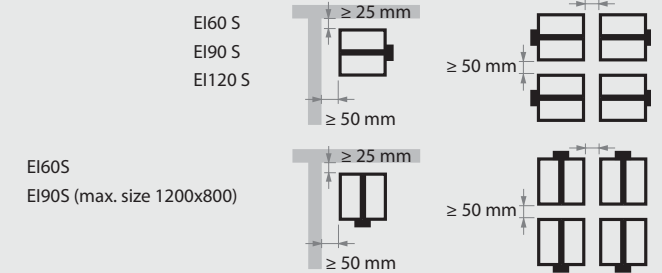

- To be read in conjunction with the CU2 Fire Damper Technical Datasheet.
- Guidelines acc. to DW144/145 (not required for CE):
 - Installation lugs as shown in the drawings are available upon request.
 - Provide appropriate break-away / flexible joint between fire damper and connecting ductwork on both sides of the assembly (DW145: eg socket & spigot or flanged with appropriate fixings eg plastic cleats, clips, clamps, bolts, aluminium alloy rivets etc.).
 - Provide a panel in the adjacent ductwork to allow access to the internal components of the fire damper. Rf-T can provide an inspection opening on the damper body upon request (option UL).
 - Ductwork must be independently supported and installed (DW144).
- Dimensions in mm unless otherwise stated.

TECHNICAL DATASHEET



INSPECTION AND HANDOVER CHECK LIST



PLAN TITLE

CU2 fire damper in rigid supporting construction. Installation detail with gypsum based plaster.

CLASSIFICATION

EI 60/90/120 (ve i↔o)S



REV
B

DATE
24/09/2024

